



BUILDING & HARDWARE DISTRIBUTOR IN AUSTRALIA

- (+61) 45 983 1963
- 86A Southern Cross Circle, Ocean Reef
- Perth Western Australia
- info@bhdaustralia.com

WWW.BHDAUSTRALIA.COM





36301400
Clothes hook
Material: Zinc alloy
Finish: Chrome
Number: 0009850

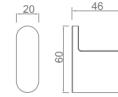

36501400
Soap holder
Material: Zinc alloy
Finish: Chrome
Number: 0019250

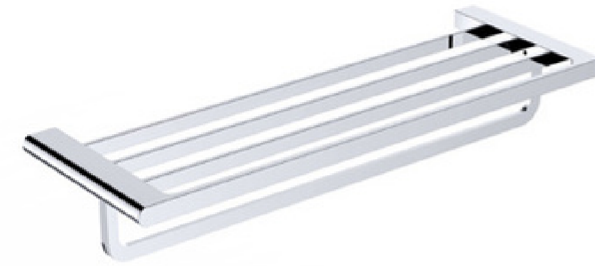

36901400
Towel rack
Material: Zinc alloy
Finish: Chrome
Number: 0074520

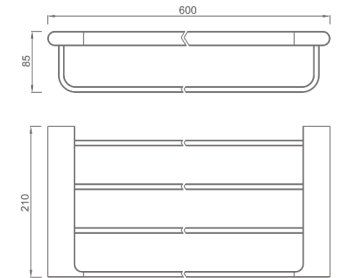

36812300
Tissue holder
Material: Zinc alloy
Finish: Chrome
Number: 0025380

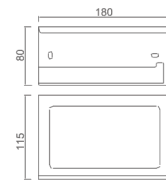

36401400
Single cup holder
Material: Zinc alloy
Finish: Chrome
Number: 0019250

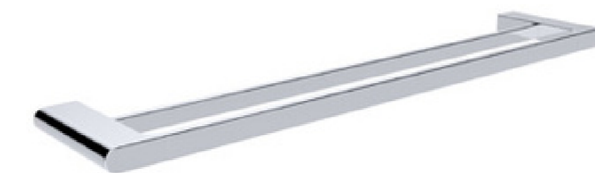
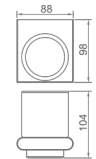

36102400
Double towel bar
Material: Zinc alloy
Finish: Chrome
Number: 0043500



36801400
Tissue holder
Material: Zinc alloy
Finish: Chrome
Number: 0017500

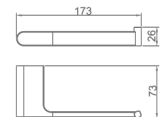

36503400
Soap dispenser holder
Material: Zinc alloy
Finish: Chrome
Number: 0022500

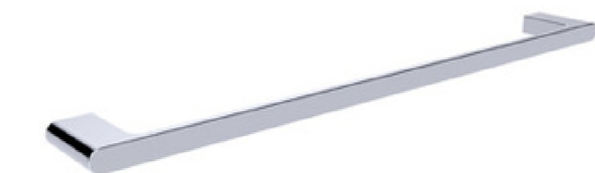
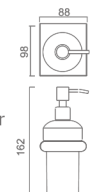

36101400
Single towel bar
Material: Zinc alloy
Finish: Chrome
Number: 0028500

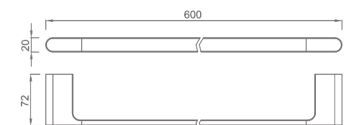

36201400
Towel ring
Material: Zinc alloy
Finish: Chrome
Number: 0022500

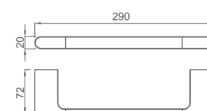

36601400
Toilet brush holder
Material: Zinc alloy
Finish: Chrome
Number: 0027500

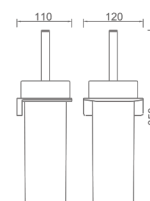



36301322
Clothes hook
Material: SUS304
Finish: Black
Number: 0014750

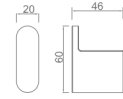

36501322
Soap holder
Material: Zinc alloy
Finish: Black
Number: 0021500

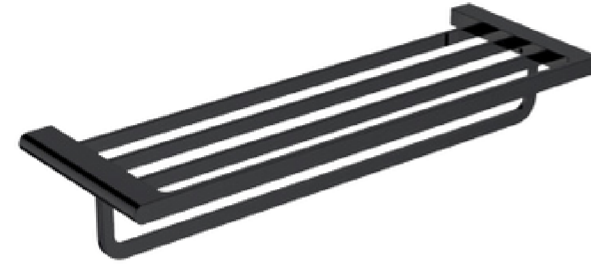
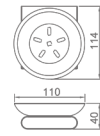

36901322
Towel rack
Material: SUS304
Finish: Black
Number: 0074550

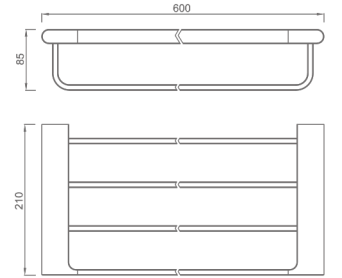

36812322
Tissue holder
Material: SUS304
Finish: Black
Number: 0028500

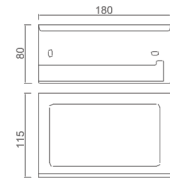

36401322
Single cup holder
Material: Zinc alloy
Finish: Black
Number: 0021500



36102322
Double towel bar
Material: SUS304
Finish: Black
Number: 0040940



36801322
Tissue holder
Material: SUS304
Finish: Black
Number: 0019300

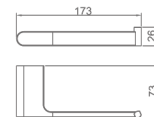

36503322
Soap dispenser holder
Material: Zinc alloy
Finish: Black
Number: 0025800



36101322
Single towel bar
Material: SUS304
Finish: Black
Number: 0031740



36201322
Towel ring
Material: SUS304
Finish: Black
Number: 0026500



36601322
Toilet brush holder
Material: Zinc alloy
Finish: Black
Number: 0031800

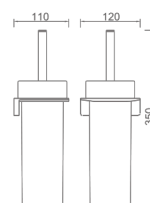



V1301322
Clothes hook
Material: SUS304
Finish: Black
Number: 0012300

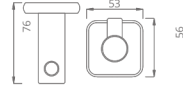

V1801322
Tissue holder
Material: SUS304
Finish: Black
Number: 0017800

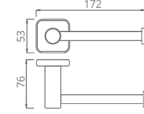

V1901322
Towel rack
Material: SUS304
Finish: Black
Number: 0049800

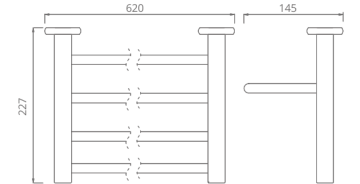

V1501322
Soap holder
Material: SUS304
Finish: Black
Number: 0017800

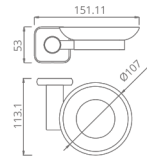

V1802322
Tissue holder
Material: SUS304
Finish: Black
Number: 0026100

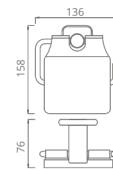

V1102322
Double towel bar
Material: SUS304
Finish: Black
Number: 0028900

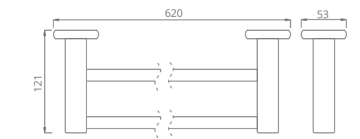

V1201322
Towel ring
Material: SUS304
Finish: Black
Number: 0018900

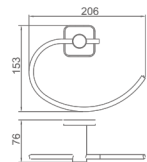

V1811322
Soap basket
Material: SUS304
Finish: Black
Number: 0027500

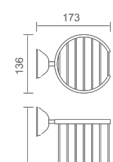

V1401322
Single cup holder
Material: SUS304
Finish: Black
Number: 0017800

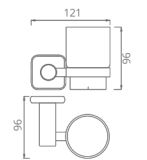

V1503322
Soap dispenser holder
Material: SUS304
Finish: Black
Number: 0022800

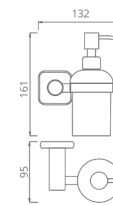

V1101322
Single towel bar
Material: SUS304
Finish: Black
Number: 0022800

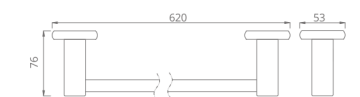

V1402322
Double cups holder
Material: SUS304
Finish: Black
Number: 0021500

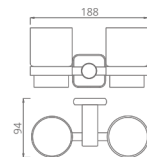

V1601322
Toilet brush holder
Material: SUS304
Finish: Black
Number: 0022800

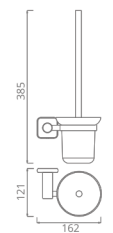



16301100
Clothes hook
Material: Brass
Finish: Chrome
Number: 0014700



16501100
Soap holder
Material: Brass
Finish: Chrome
Number: 0016800

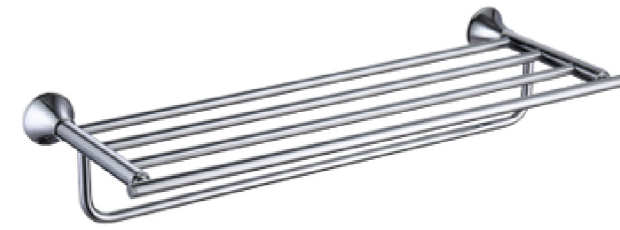

16902100
Towel rack
Material: Brass
Finish: Chrome
Number: 0065800

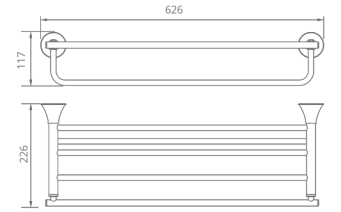

16802100
Tissue holder
Material: Brass
Finish: Chrome
Number: 0017500

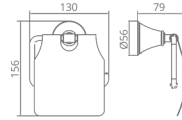

16401100
Single cup holder
Material: Brass
Finish: Chrome
Number: 0014700

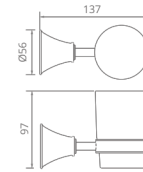

16102100
Single towel bar
Material: Brass
Finish: Chrome
Number: 0036950

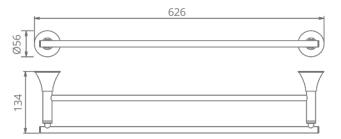

16503100
Soap dispenser holder
Material: Brass
Finish: Chrome
Number: 0016800



16101100
Single towel bar
Material: Brass
Finish: Chrome
Number: 0028900

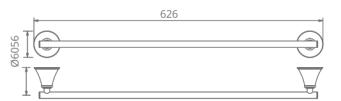

16601100
Toilet brush holder
Material: Brass
Finish: Chrome
Number: 0019950

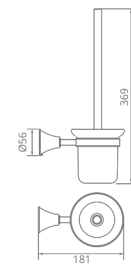



29302400
Clothes hook
Material: Zinc alloy
Finish: Chrome
Number: 0012500

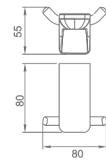

29502400
Soap basket
Material: Zinc alloy
Finish: Chrome
Number: 0019000

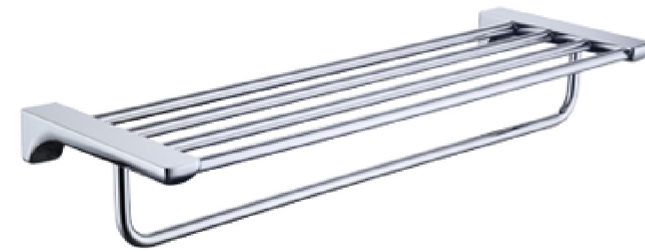
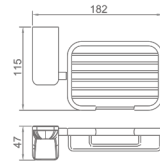

29901400
Towel rack
Material: Zinc alloy
Finish: Chrome
Number: 0052500

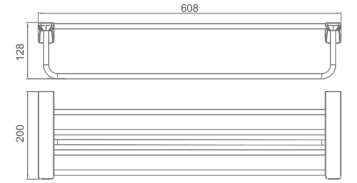

29201400
Towel ring
Material: Zinc alloy
Finish: Chrome
Number: 0019000

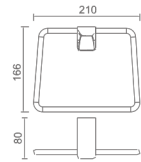

29802400
Tissue holder
Material: Zinc alloy
Finish: Chrome
Number: 0019000

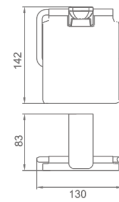

29102400
Double towel bar
Material: Zinc alloy
Finish: Chrome
Number: 0029000

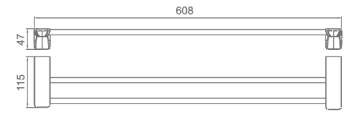

29401400
Single cup holder
Material: Zinc alloy
Finish: Chrome
Number: 0016000

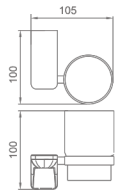

29801400
Tissue holder
Material: Zinc alloy
Finish: Chrome
Number: 0017500

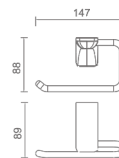

29101400
Single towel bar
Material: Zinc alloy
Finish: Chrome
Number: 0022500

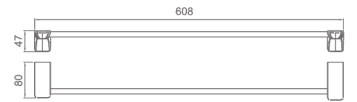

29503400
Soap dispenser holder
Material: Zinc alloy
Finish: Chrome
Number: 0018500

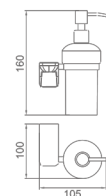

29601400
Toilet brush holder
Material: Zinc alloy
Finish: Chrome
Number: 0022000

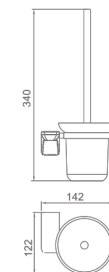



29302422
Clothes hook
Material: Zinc alloy
Finish: Black
Number: 0015000

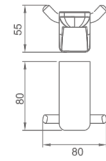

29501422
Soap holder
Material: Zinc alloy
Finish: Black
Number: 0019200

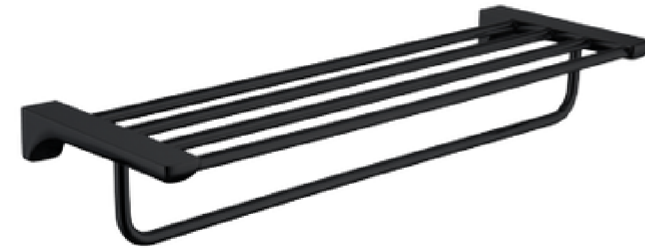
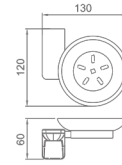

29901422
Towel rack
Material: Zinc alloy
Finish: Black
Number: 0063500

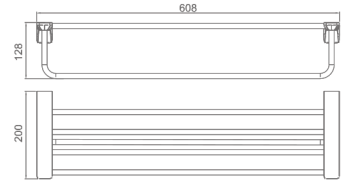

29201422
Towel ring
Material: Zinc alloy
Finish: Black
Number: 0022800

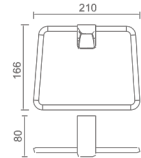

29802422
Tissue holder
Material: Zinc alloy
Finish: Black
Number: 0022800

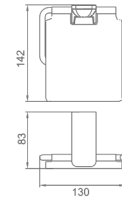

29102422
Double towel bar
Material: Zinc alloy
Finish: Black
Number: 0034800



29401422
Single cup holder
Material: Zinc alloy
Finish: Black
Number: 0019200

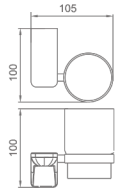

29801422
Tissue holder
Material: Zinc alloy
Finish: Black
Number: 0021000

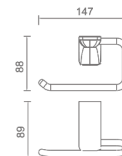

29101422
Single towel bar
Material: Zinc alloy
Finish: Black
Number: 0027000

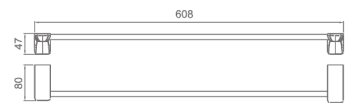

29503422
Soap dispenser holder
Material: Zinc alloy
Finish: Black
Number: 0021500

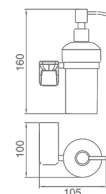

29601422
Toilet brush holder
Material: Zinc alloy
Finish: Black
Number: 0026400

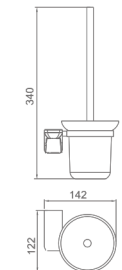

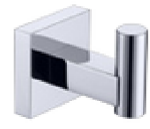

23301100
 Clothes hook
 Material: Brass
 Finish: Chrome
 Number: 0014800

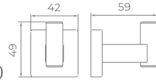

23803100
 Tissue holder
 Material: Brass
 Finish: Chrome
 Number: 0028600

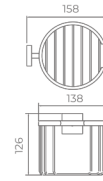

23802100
 Tissue holder
 Material: Brass
 Finish: Chrome
 Number: 0018600

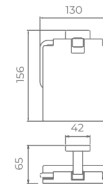

23401100
 Single cup holder
 Material: Brass
 Finish: Chrome
 Number: 0010500

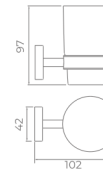

23601100
 Toilet brush holder
 Material: Brass
 Finish: Chrome
 Number: 0016700

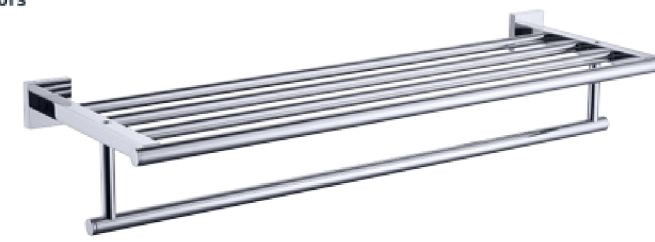
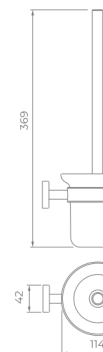

23901100
 Towel rack
 Material: Brass
 Finish: Chrome
 Number: 0089500

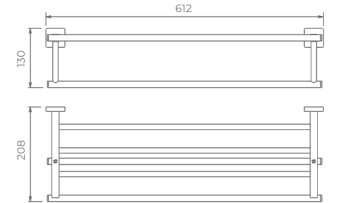

23102100
 Double towel bar
 Material: Brass
 Finish: Chrome
 Number: 0039900

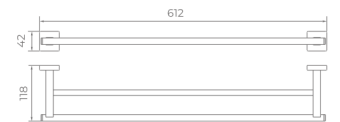

23101100
 Single towel bar
 Material: Brass
 Finish: Chrome
 Number: 0031900



47503100
 Glass shelf
 Material: Brass
 Finish: Chrome
 Number: 0019500

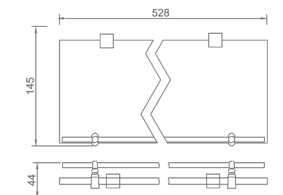

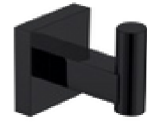

23301109
Clothes hook
Material: Brass
Finish: Black
Number: 0016800

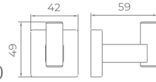

2380309
Towel ring
Material: Brass
Finish: Black
Number: 0032800

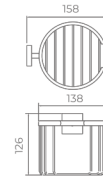

23802109
Tissue holder
Material: Brass
Finish: Black
Number: 0022800

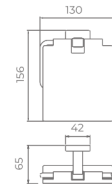

23401109
Single cup holder
Material: Brass
Finish: Black
Number: 0013870

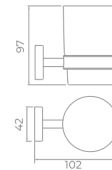

23601109
Toilet brush holder
Material: Brass
Finish: Black
Number: 0021700

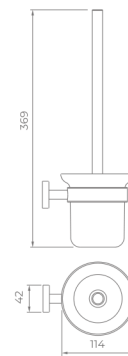

23901109
Towel rack
Material: Brass
Finish: Black
Number: 0096500

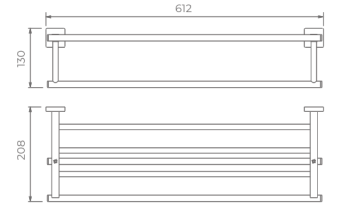

23102109
Double towel bar
Material: Brass
Finish: Black
Number: 0047800

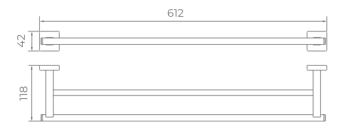

23101109
Single towel bar
Material: Brass
Finish: Black
Number: 0033800



47503109
Glass shelf
Material: Brass
Finish: Black
Number: 0019500

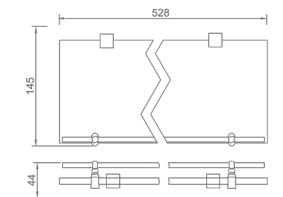



21302109
Clothes hook
Material: Brass
Finish: Black
Number: 0022000

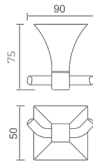

21502109
Soap basket
Material: Brass
Finish: Black
Number: 0028750

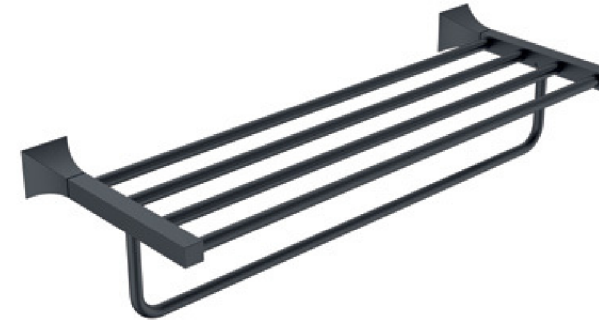
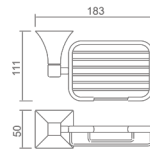

21901109
Towel rack
Material: Brass
Finish: Black
Number: 0112350



21201109
Towel ring
Material: Brass
Finish: Black
Number: 0026250

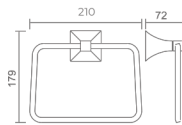

21801109
Tissue holder
Material: Brass
Finish: Black
Number: 0022000

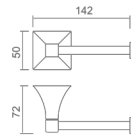

21102109
Double towel bar
Material: Brass
Finish: Black
Number: 0056500

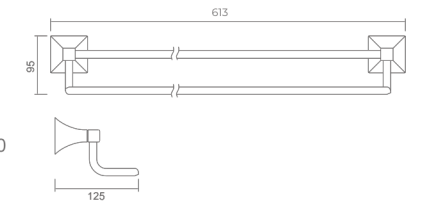

21401109
Single cup holder
Material: Brass
Finish: Black
Number: 0023600

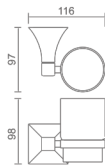

21802109
Tissue holder
Material: Brass
Finish: Black
Number: 0027300

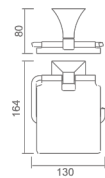

21101109
Single towel bar
Material: Brass
Finish: Black
Number: 0042600



21402109
Double cups holder
Material: Brass
Finish: Black
Number: 0030850

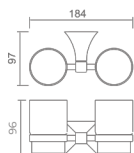

21601109
Toilet brush holder
Material: Brass
Finish: Black
Number: 0029750

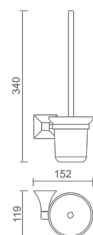

21701109
Glass shelf
Material: Brass
Finish: Black
Number: 0056800

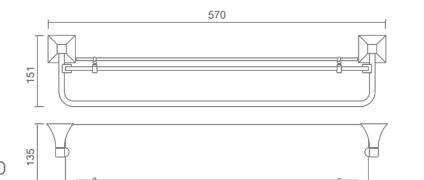



22301100
Clothes hook
Material: Brass
Finish: Chrome
Number: 0013350

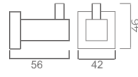

22511100
Soap holder
Material: Brass
Finish: Chrome
Number: 0017000

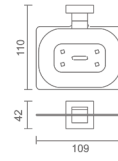

22201100
Towel ring
Material: Brass
Finish: Chrome
Number: 0023350

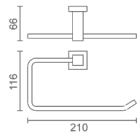

22801100
Tissue holder
Material: Brass
Finish: Chrome
Number: 0020200

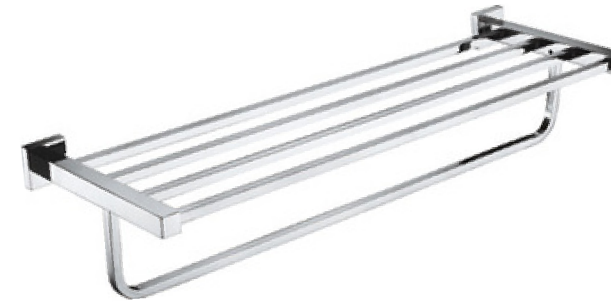
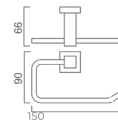

22902100
Towel rack
Material: Brass
Finish: Chrome
Number: 0087500

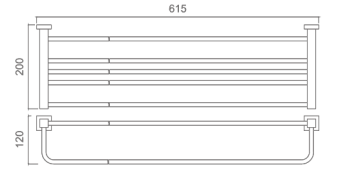

22102100
Double towel bar
Material: Brass
Finish: Chrome
Number: 0041200

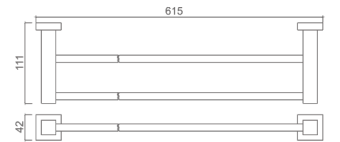

22503100
Soap dispenser holder
Material: Brass
Finish: Chrome
Number: 0022300

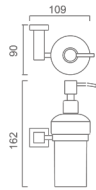

22802100
Tissue holder
Material: Brass
Finish: Chrome
Number: 0020200

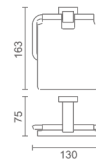

22101100
Single towel bar
Material: Brass
Finish: Chrome
Number: 0029900

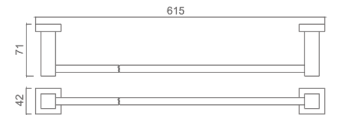

22401100
Single cup holder
Material: Brass
Finish: Chrome
Number: 0018350

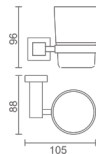

22811100
Tissue holder
Material: Brass
Finish: Chrome
Number: 0018350

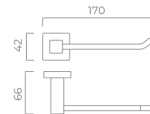

22402100
Double cups holder
Material: Brass
Finish: Chrome
Number: 0022800

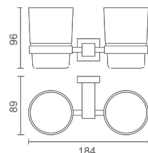

22601100
Toilet brush holder
Material: Brass
Finish: Chrome
Number: 0024400

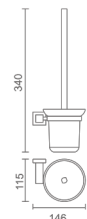

22711100
Glass shelf
Material: Brass
Finish: Chrome
Number: 0039650

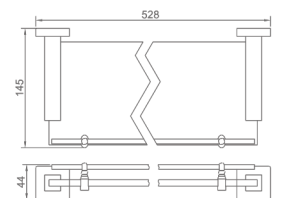

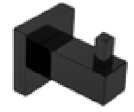

22301122
Clothes hook
Material: Brass
Finish: Black
Number: 0016050

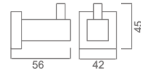

22511122
Soap holder
Material: Brass
Finish: Black
Number: 0020400

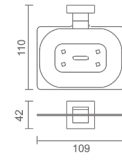

22201122
Towel ring
Material: Brass
Finish: Black
Number: 0028050

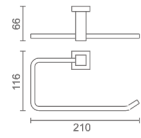

22801122
Tissue holder
Material: Brass
Finish: Black
Number: 0024250

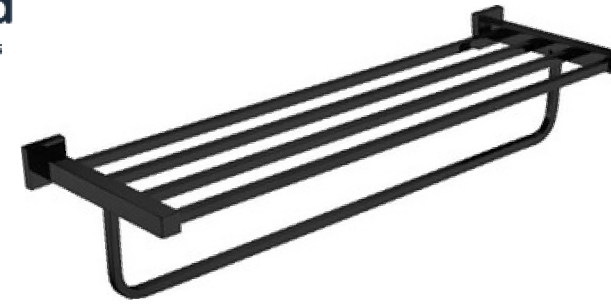
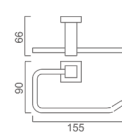

22902122
Towel rack
Material: Brass
Finish: Black
Number: 0102000

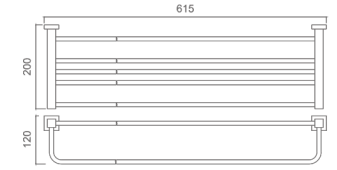

22503122
Soap dispenser
holder Material: Brass
Finish: Black
Number: 0022300

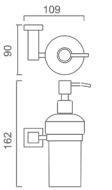

22802122
Tissue holder
Material: Brass
Finish: Black
Number: 0024200

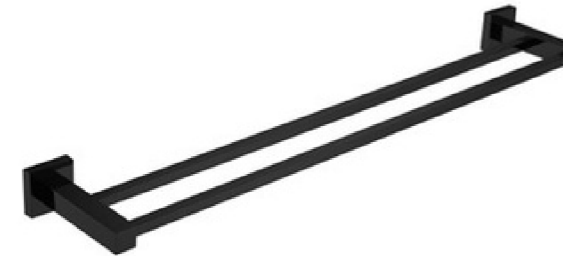
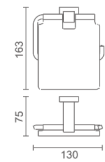

22102122
Double towel bar
Material: Brass
Finish: Black
Number: 0049300

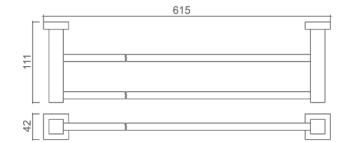

22401122
Single cup holder
Material: Brass
Finish: Black
Number: 0022000

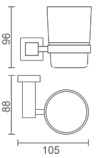

22811122
Tissue holder
Material: Brass
Finish: Black
Number: 0022800

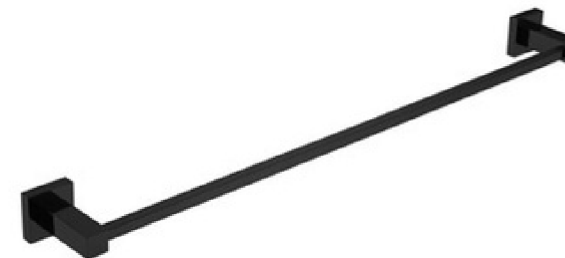
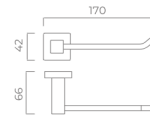

22101122
Single towel bar
Material: Brass
Finish: Black
Number: 0033800

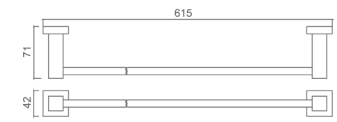

22402122
Double cups holder
Material: Brass
Finish: Black
Number: 0027350

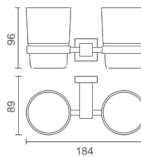

22601122
Toilet brush holder
Material: Brass
Finish: Black
Number: 0029280

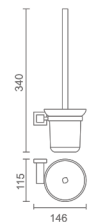



27301100
Clothes hook
Material: Brass
Finish: Chrome
Number: 0014250



27502100
Soap basket
Material: Brass
Finish: Chrome
Number: 0022500

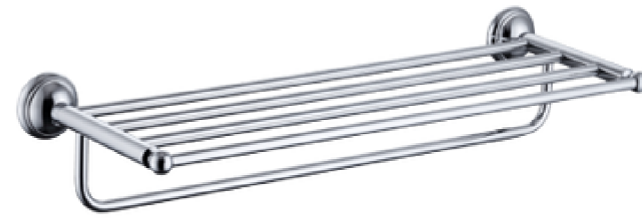
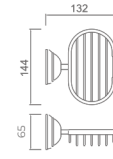

27901100
Towel rack
Material: Brass
Finish: Chrome
Number: 0069800

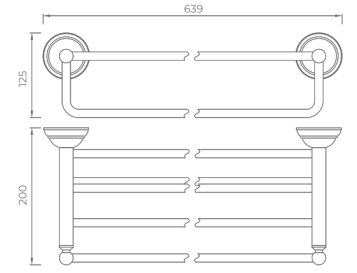

27201100
Towel ring
Material: Brass
Finish: Chrome
Number: 0022500

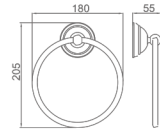

27801100
Soap basket
Material: Brass
Finish: Chrome
Number: 0026200

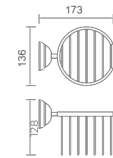

27102100
Double towel bar
Material: Brass
Finish: Chrome
Number: 0047000



27401100
Single cup holder
Material: Brass
Finish: Chrome
Number: 0019500



27802100
Tissue holder
Material: Brass
Finish: Chrome
Number: 0022500

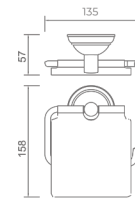

27101100
Single towel bar
Material: Brass
Finish: Chrome
Number: 0032800



27503100
Soap dispenser
holder Material: Brass
Finish: Chrome
Number: 0026250

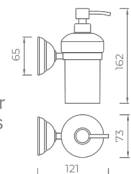

27601100
Toilet brush holder
Material: Brass
Finish: Chrome
Number: 0029500

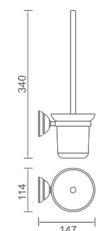



13302100
Clothes hook
Material: Brass
Finish: Chrome
Number: 0016500

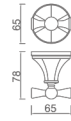

13501100
Soap holder
Material: Brass
Finish: Chrome
Number: 0021250

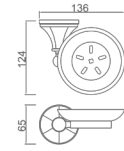

13901100
Towel rack
Material: Brass
Finish: Chrome
Number: 0069800

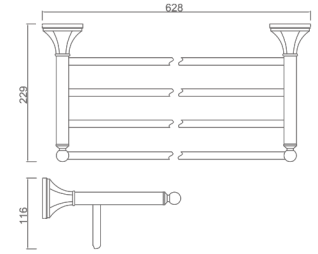

13201100
Towel ring
Material: Brass
Finish: Chrome
Number: 0021250

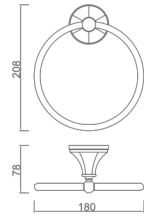

13502100
Soap basket
Material: Brass
Finish: Chrome
Number: 0026500

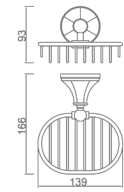

13102100
Double towel bar
Material: Brass
Finish: Chrome
Number: 0041500

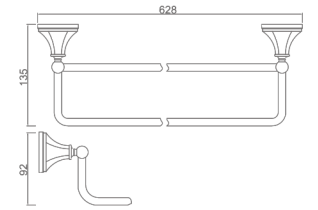

13402100
Double cups holder
Material: Brass
Finish: Chrome
Number: 0026500

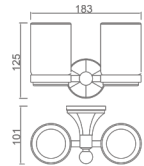

13802100
Tissue holder
Material: Brass
Finish: Chrome
Number: 0022500

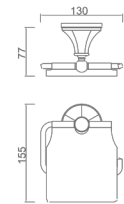

13101100
Single towel bar
Material: Brass
Finish: Chrome
Number: 0032800

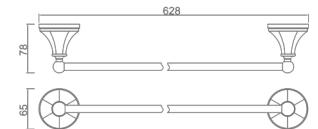

13503100
Soap dispenser
holder Material: Brass
Finish: Chrome
Number: 0026500

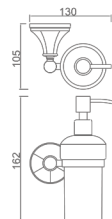

13601100
Toilet brush holder
Material: Brass
Finish: Chrome
Number: 0032550

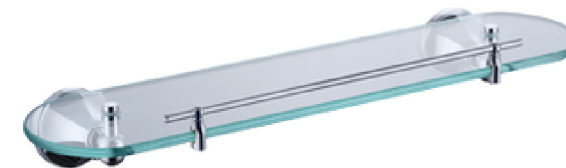
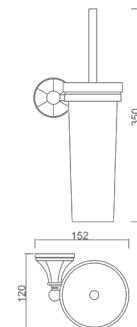

13701100
Glass shelf
Material: Brass
Finish: Chrome
Number: 0045350

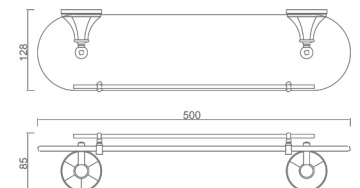



15302301
Clothes hook
Material: SUS304
Finish: Brushed
Number: 0012500

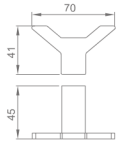

15401301
Single cup holder
Material: SUS304
Finish: Brushed
Number: 016500

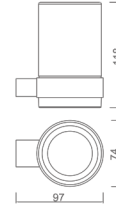

15901301
Towel rack
Material: SUS304
Finish: Brushed
Number: 0053500

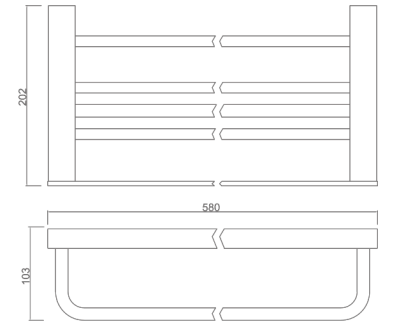

15801301
Tissue holder
Material: SUS304
Finish: Brushed
Number: 0020800

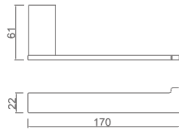

15501301
Soap holder
Material: SUS304
Finish: Brushed
Number: 0016500



15102301
Double towel bar
Material: SUS304
Finish: Brushed
Number: 0032200



15803301
Tissue holder
Material: SUS304
Finish: Brushed
Number: 0024200

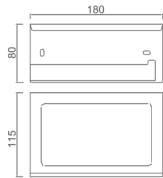

18503301
Soap dispenser holder
Material: SUS304
Finish: Brushed
Number: 0021500

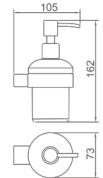

1510 13 0 1
Single towel bar
Material: SUS304
Finish: Brushed
Number: 0024850

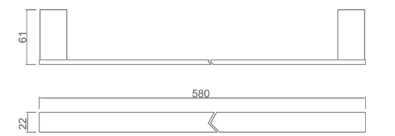

15802301
Tissue holder
Material: SUS304
Finish: Brushed
Number: 0038300

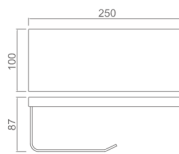

15601301
Toilet brush holder
Material: SUS304
Finish: Brushed
Number: 0026500

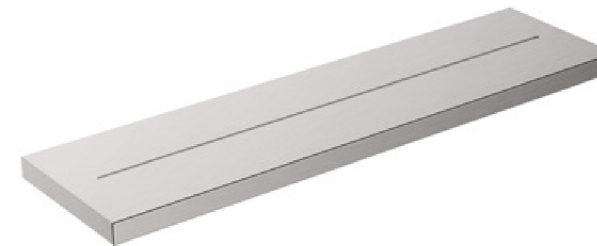
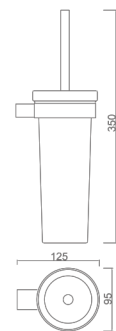

15701301
Shelf
Material: Brass
Finish: Brushed
Number: 0053500

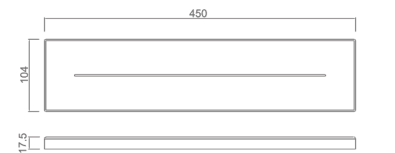



15302323
Clothes hook
Material: SUS304
Finish: Gun gray
Number: 0018200

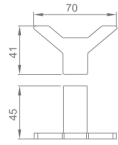

15401323
Single cup holder
Material: SUS304
Finish: Gun gray
Number: 0026640

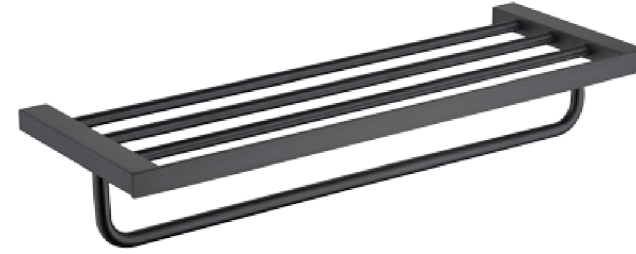
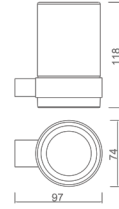

15901323
Towel rack
Material: SUS304
Finish: Gun gray
Number: 0083400

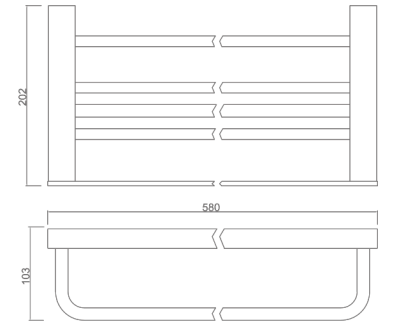

15801323
Tissue holder
Material: SUS304
Finish: Gun gray
Number: 0029900

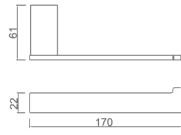

155013023
Soap holder
Material: SUS304
Finish: Gun gray
Number: 0026640

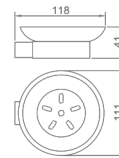

15102323
Double towel bar
Material: SUS304
Finish: Gun gray
Number: 0046250



15803323
Tissue holder
Material: SUS304
Finish: Gun gray
Number: 0034850

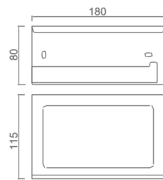

15503323
Soap dispenser holder
Material: SUS304
Finish: Gun gray
Number: 0030960

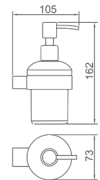

1510 13 2 3
Single towel bar
Material: SUS304
Finish: Gun gray
Number: 0035780

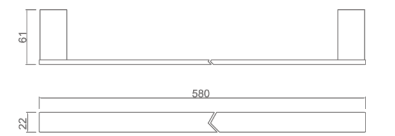

15802323
Tissue holder
Material: SUS304
Finish: Gun gray
Number: 0043920

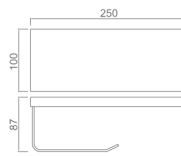

15601323
Toilet brush holder
Material: SUS304
Finish: Gun gray
Number: 0038940

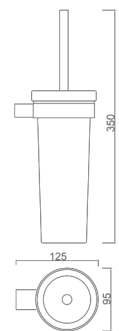

15701323
Shelf
Material: Brass
Finish: Gun gray
Number: 0083460

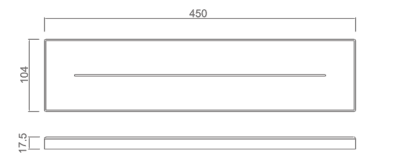



V3301302
Clothes hook
Material: SUS304
Finish: Chrome
Number: 0008600

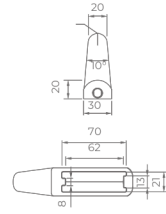

V1802302
Tissue holder
Material: SUS304
Finish: Chrome
Number: 0018800

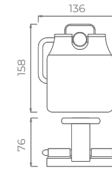

28801302
Tissue holder
Material: SUS304
Finish: Chrome
Number: 0018800

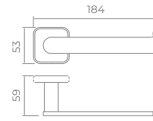

28401302
Single cup holder
Material: SUS304
Finish: Chrome
Number: 0012500

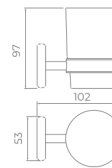

28601302
Toilet brush holder
Material: SUS304
Finish: Chrome
Number: 0018200

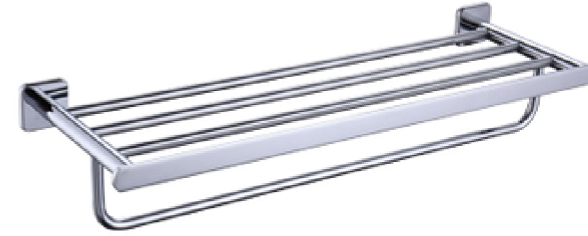
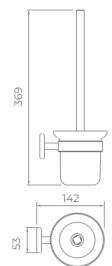

28901302
Towel rack
Material: SUS304
Finish: Chrome
Number: 0052500



28102302
Double towel bar
Material: SUS304
Finish: Chrome
Number: 0033880

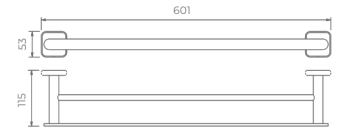

28101302
Single towel bar
Material: SUS304
Finish: Chrome
Number: 0026520





10301301
Clothes hook
Material: SUS304
Finish: Brushed
Number: 0005750

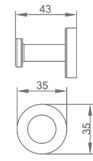

10802301
Tissue holder
Material: SUS304
Finish: Brushed
Number: 0016000

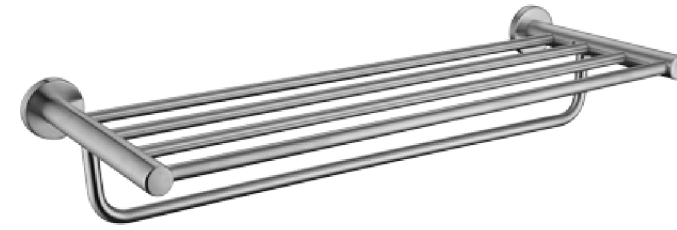
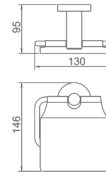

10901301
Towel rack
Material: SUS304
Finish: Brushed
Number: 0029800

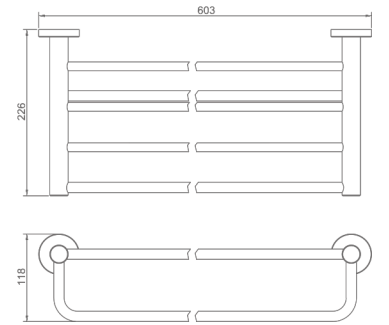

10201301
Towel ring
Material: SUS304
Finish: Brushed
Number: 0016000

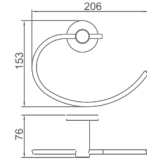

10812301
Tissue holder
Material: SUS304
Finish: Brushed
Number: 0016800

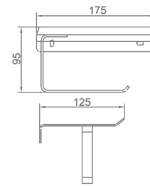

10102301
Double towel bar
Material: SUS304
Finish: Brushed
Number: 0020450

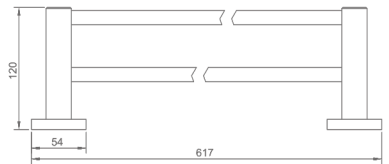

10401301
Single cup holder
Material: SUS304
Finish: Brushed
Number: 0013550

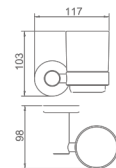

10503301
Soap dispenser holder
Material: SUS304
Finish: Brushed
Number: 0016500

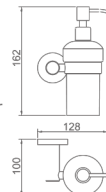

10101301
Single towel bar
Material: SUS304
Finish: Brushed
Number: 0017600



10501301
Soap holder
Material: SUS304
Finish: Brushed
Number: 0013550

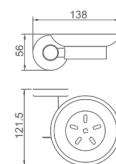

10601301
Toilet brush holder
Material: SUS304
Finish: Brushed
Number: 0013800

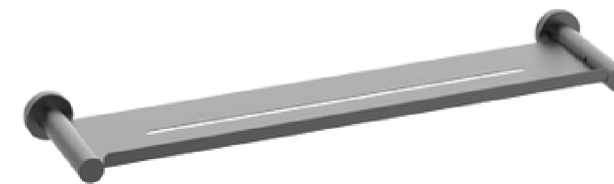

10701301
Single shelf
Material: SUS304
Finish: Brushed
Number: 0032500

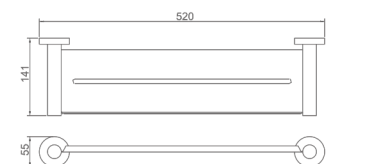

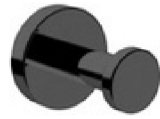

10301323
Clothes hook
Material: SUS304
Finish: Gun gray
Number: 0007250

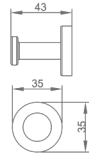

10802323
Tissue holder
Material: SUS304
Finish: Gun gray
Number: 0022850

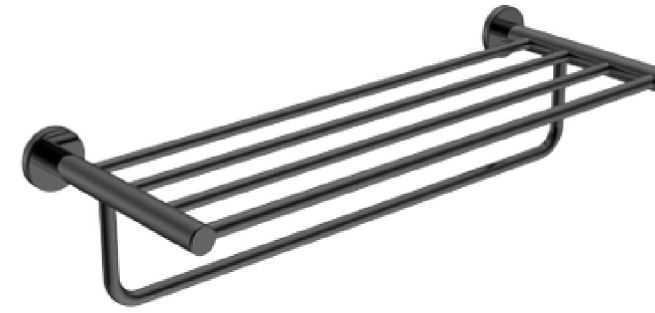
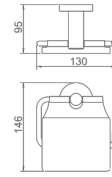

10901323
Towel rack
Material: SUS304
Finish: Gun gray
Number: 0054600

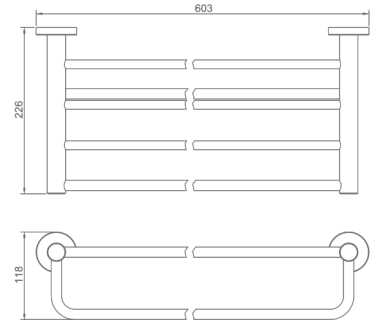

10201323
Towel ring
Material: SUS304
Finish: Gun gray
Number: 0023760

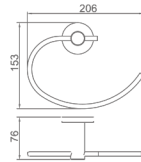

10812323
Tissue holder
Material: SUS304
Finish: Gun gray
Number: 0026000

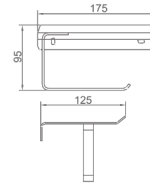

10102323
Double towel bar
Material: SUS304
Finish: Gun gray
Number: 0039000

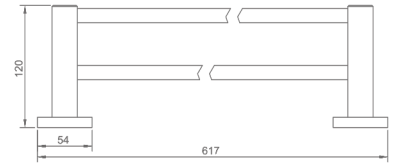

10401323
Single cup holder
Material: SUS304
Finish: Gun gray
Number: 0020450

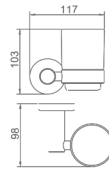

10503323
Soap dispenser holder
Material: SUS304
Finish: Gun gray
Number: 0022000

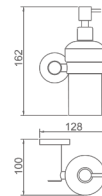

10101323
Towel rack
Material: SUS304
Finish: Gun gray
Number: 0025300

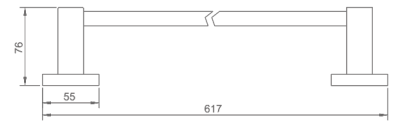

10501323
Soap holder
Material: SUS304
Finish: Gun gray
Number: 0020450

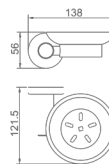

10601323
Toilet brush holder
Material: SUS304
Finish: Gun gray
Number: 0020500



10701323
Single shelf
Material: SUS304
Finish: Gun gray
Number: 0046500

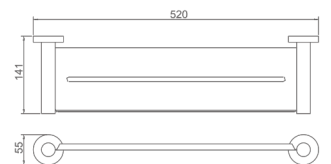

SUITE SERIES



10051302
Material: SUS304
Polishing finish
Number: 0099500

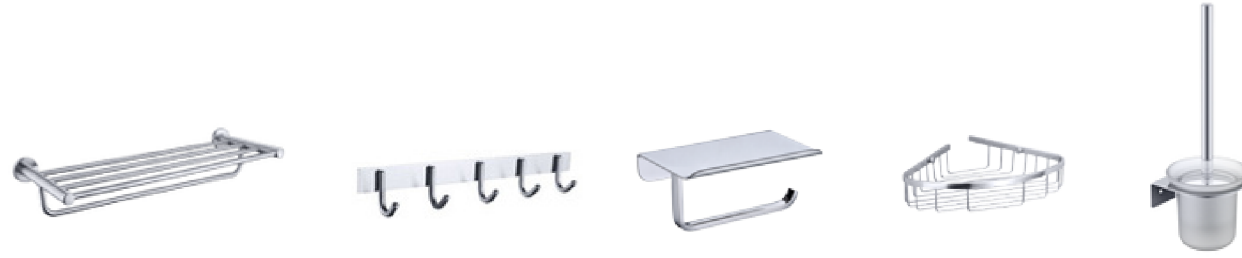

29041400
Material: Zinc alloy
Finish: Chrome
Number: 0103800



36061100
Material: Brass
Finish: Chrome
Number: 0141000



36042320
Material: SUS304
Finish: Brushed gold
Number: 0158000



V10041322
Material: SUS304
Finish: Black
Number: 0110800



22061100
Material: Brass
Finish: Chrome
Number: 0109100



18043222
Material: 201#
Finish: Black
Number: 0089500





18902100
Towel rack
Material: Brass
Finish: Chrome
Number: 0035500

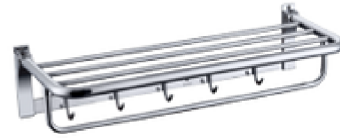

18906200
Towel rack
Material: 201#
Finish: Chrome
Number: 0058950



18923301
Towel rack
Material: SUS304
Finish: Brushed
Number: 0062500

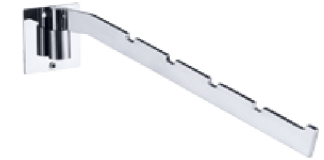

18926302
Clothes holder
Material: SUS304
Polishing finish
Number: 0022500



18904100
Towel rack
Material: Brass
Finish: Chrome
Number: 0041000



18914100
Towel rack
Material: Brass
Finish: Chrome
Number: 0067500



18924301
Towel rack
Material: SUS304
Finish: Brushed
Number: 0059800

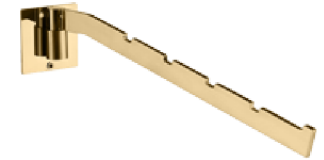

18926320
Clothes holder
Material: SUS304
Finish: Brushed gold
Number: 0025870



18905200
Towel rack
Material: 201#
Finish: Chrome
Number: 0033800

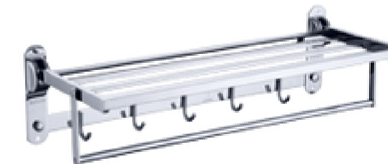

18922302
Towel rack
Material: SUS304
Polishing finish
Number: 0062300



18926323
Clothes holder
Material: SUS304
Finish: Gun gray
Number: 0029800



18907100
Towel rack
Material: Brass
Finish: Chrome
Number: 0041000

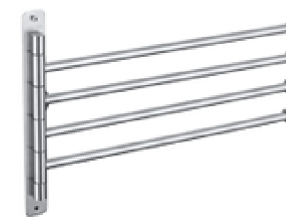

18925302
Towel rack
Material: SUS304
Polishing finish
Number: 0031800

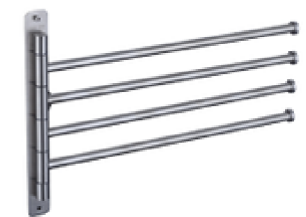

18925301
Towel rack
Material: SUS304
Finish: Brushed
Number: 0026500



62306301
Floor tissue holder
Material: SUS304
Finish: Brushed
Number: 0058200



62306320
Floor tissue holder
Material: SUS304
Finish: Brushed gold
Number: 0065800



62306323
Floor tissue holder
Material: SUS304
Finish: Gun gray
Number: 0071500



62305302
Toilet brush holder
Material: SUS304
Polishing finish
Number: 0072600



62305320
Toilet brush holder
Material: SUS304
Finish: Brushed gold
Number: 0138500



62305323
Toilet brush holder
Material: SUS304
Finish: Gun gray
Number: 0148200



62304301
Floor towel rack
Material: SUS304
Finish: Brushed
Number: 0118500



62304320
Floor towel rack
Material: SUS304
Finish: Brushed gold
Number: 0127000

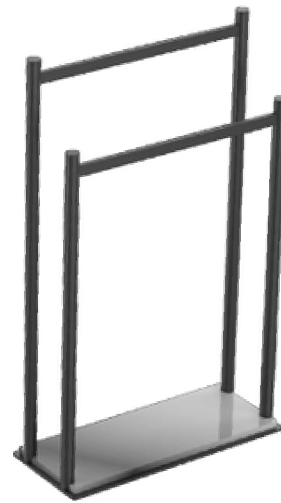

62304323
Floor towel rack
Material: SUS304
Finish: Gun gray
Number: 0137000



62301301
Toilet brush holder
Material: SUS304
Finish: Polishing
Number: 0073800

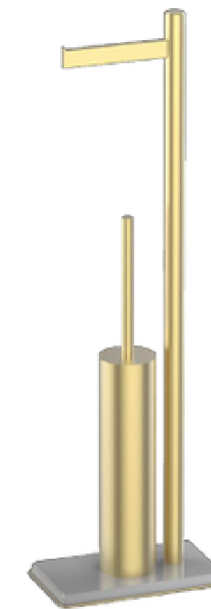

62301320
Toilet brush holder
Material: SUS304
Finish: Brushed gold
Number: 0082100



62301323
Toilet brush holder
Material: SUS304
Finish: Gun gray
Number: 0092550

ACCESSORY



6130310
0
6130410
0
6130510
Clothes hook
Material: Brass
Finish: Chrome
Number: 0015750
Number: 0019250
Number: 0023600
Number: 0026250



6141310
0
6141410
0
6141510
Clothes hook
Material: Brass
Finish: Chrome
Number: 0015750
Number: 0019250
Number: 0023600
Number: 0026250



6120310
0
6120410
0
6120510
Clothes hook
Material: Brass
Finish: Chrome
Number: 0015750
Number: 0019250
Number: 0023600
Number: 0026250

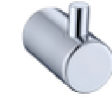

6130110
0
6130110
5
6130110
6
6130110
Material: Brass
Number: 0007800
Number: 0009750
Number: 0009750
Number: 0009750

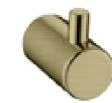
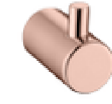
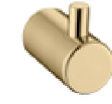

6140310
00
6140410
00
6140510
Clothes hook
Material: Brass
Finish: Chrome
Number: 0015750
Number: 0019250
Number: 0023600
Number: 0026250

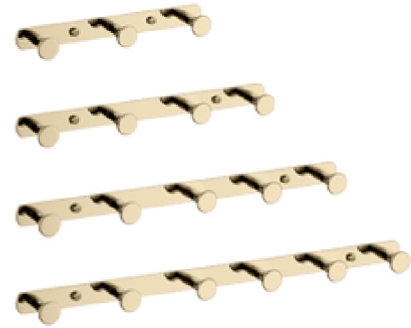

6141310
5
6141410
5
6141510
Clothes hook
Material: Brass
Finish: Zirconium gold
Number: 0018100
Number: 0024150
Number: 0029500
Number: 0036250



6120310
4
6120410
4
6120510
Clothes hook
Material: Brass
Finish: Titanium gold
Number: 0018100
Number: 0024150
Number: 0029500
Number: 0036250



6140310
22
6140410
22
6140510
Clothes hook
Material: Brass
Finish: Black
Number: 0018100
Number: 0024150
Number: 0029500
Number: 0036250

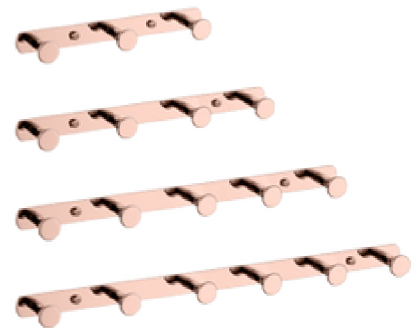

6141310
6
6141410
6
6141510
Clothes hook
Material: Brass
Finish: Rose gold
Number: 0018100
Number: 0024150
Number: 0029500
Number: 0036250



61702306
Clothes Line
Material: SUS304
Finish: Rose gold
Number: 0017330



61702305
Clothes Line
Material: SUS304
Finish: Gold
Number: 0017330



61702309
Clothes Line
Material: SUS304
Finish: Black
Number: 0017330

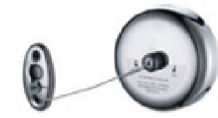

61701300
Clothes Line
Material: SUS304
Polishing finish
Number: 0013130

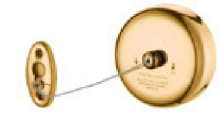

61701304
Clothes Line
Material: SUS304
Finish: Titanium gold
Number: 0017330



61701309
Clothes Line
Material: SUS304
Finish: Black
Number: 0017330



6100130
2
6100130
1
Clothes hook
Material: SUS304
Number: 0012750
Number: 0017500
Number: 0018500



6115330
1
6115430
1
6115530
1
Clothes hook
Material: SUS304
Finish: Brushed
Number: 0009000
Number: 0012000
Number: 0015000
Number: 0018000



6113330
1
6113430
1
6113530
1
Clothes hook
Material: SUS304
Finish: Brushed
Number: 0007500
Number: 0010000
Number: 0012500
Number: 0015000



6110530
1
6110630
1
6110730
1
Clothes hook
Material: SUS304
Finish: Brushed
Number: 0007500
Number: 0010000
Number: 0012500
Number: 0015000



6112332
3
6112432
3
6112532
3
Clothes hook
Material: SUS304
Finish: Brushed
Number: 0012500
Number: 0017500
Number: 0020500
Number: 0024000



6112332
4
6112432
4
6112532
4
Clothes hook
Material: Brass
Finish: Brushed
Number: 0012500
Number: 0017500
Number: 0020500
Number: 0024000

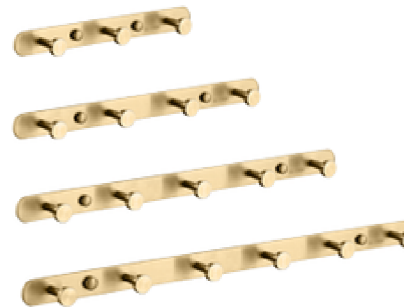

6113332
0
6113432
0
6113532
0
Clothes hook
Material: SUS304
Finish: Brushed gold
Number: 0009000
Number: 0012000
Number: 0015000
Number: 0018000

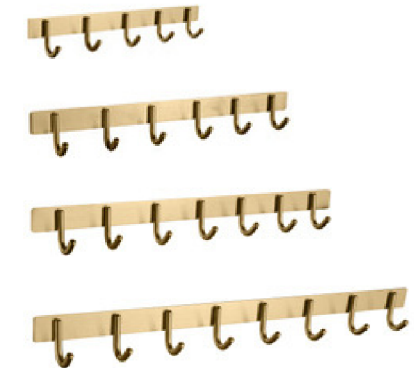

6110532
0
6110632
0
6110732
0
Clothes hook
Material: SUS304
Finish: Brushed gold
Number: 0009000
Number: 0012000
Number: 0015000
Number: 0018000

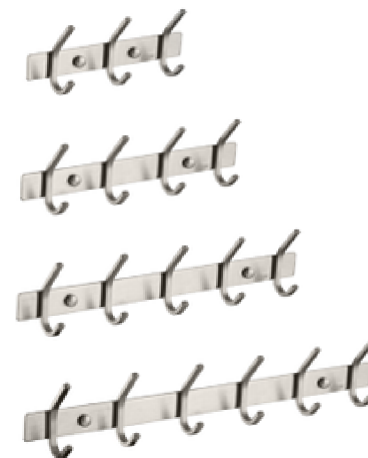

6116330
1
6116430
1
6116530
1
Clothes hook
Material: SUS304
Finish: Brushed
Number: 0009750
Number: 0013000
Number: 0016250
Number: 0019500



6117330
1
6117430
1
6117530
1
Clothes hook
Material: SUS304
Finish: Brushed
Number: 0007500
Number: 0010000
Number: 0012500
Number: 0015000



6113332
3
6113432
3
6113532
3
Clothes hook
Material: SUS304
Finish: Gun gray
Number: 0010500
Number: 0014000
Number: 0017500
Number: 0021000

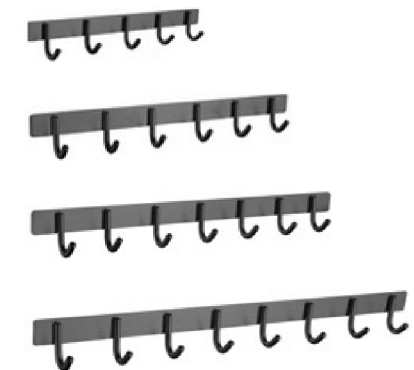

6110532
3
6110632
3
6110732
3
Clothes hook
Material: SUS304
Finish: Gun gray
Number: 0010500
Number: 0014000
Number: 0017500
Number: 0021000



47401302
K itchenw ar e
Material: SUS304
Polishing finish
Number: 0045900



47402302
K itchenw ar e
Material: SUS304
Polishing finish
Number: 0047250



47403302
K itchenw ar e
Material: SUS304
Polishing finish
Number: 0023500



47404302
K itchenw ar e
Material: SUS304
Polishing finish
Number: 0033500



47405302
K itchenw ar e
Material: SUS304
Polishing finish
Number: 0054000



47406302
K itchenw ar e
Material: SUS304
Polishing finish
Number: 0049000



47407302
K itchenw ar e
Material: SUS304
Polishing finish
Number: 0066000



47408302
K itchenw ar e
Material: SUS304
Polishing finish
Number: 0044000



47409302
K itchenw ar e
Material: SUS304
Polishing finish
Number: 0039000

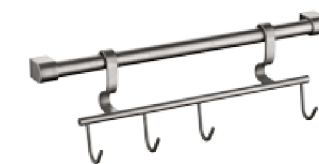

47410302
K itchenw ar e
Material: SUS304
Polishing finish
Number: 0017500



(400mm)
(800mm)
(1200mm)
K itchenw ar e
Material: SUS304
Finish: Brushed
Number: 0012500
Number: 0018900
Number: 0021000

REVEALS THE METAL TEXTURE ALWAYS
IT IS SURROUNDED BY DISTINGUISHED
SYMBOLS ALL WOMEN LOVE JEWELRY
THE PURSUIT OF NOBLENESS AND STATUS



63102302
Tissue holder
Material: SUS304
Polishing finish
Number: 0017350



63103302
Tissue holder
Material: SUS304
Polishing finish
Number: 0013150



63200301
Tissue holder
Material: SUS304
Finish: Brushed
Number: 0041000



63201301
Tissue holder
Material: SUS304
Finish: Brushed
Number: 0023800



63104302
Tissue holder
Material: SUS304
Polishing finish
Number: 0017350



63106302
Tissue holder
Material: SUS304
Polishing finish
Number: 0031500

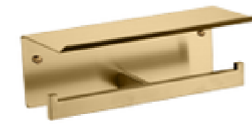

63200320
Tissue holder
Material: SUS304
Finish: Brushed gold
Number: 0049230



63201320
Tissue holder
Material: SUS304
Finish: Brushed gold
Number: 0028500



63110302
Tissue holder
Material: SUS304
Polishing finish
Number: 0068250



63114301
Tissue holder
Material: SUS304
Finish: Brushed
Number: 0057230



63200323
Tissue holder
Material: SUS304
Finish: Gun gray
Number: 0057430



63201323
Tissue holder
Material: SUS304
Finish: Gun gray
Number: 0032800

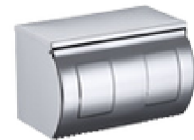

63112302
Tissue holder
Material: SUS304
Polishing finish
Number: 0021500



63111302
Tissue holder
Material: SUS304
Polishing finish
Number: 0036000



63301302
Tissue holder
Material: SUS304
Polishing finish
Number: 0032500



63302302
Tissue holder
Material: SUS304
Polishing finish
Number: 0022500



63205302
Tissue holder
Material: SUS304
Polishing finish
Number: 0025500



63303302
Tissue holder
Material: SUS304
Polishing finish
Number: 0029500



63304302
Tissue holder
Material: SUS304
Polishing finish
Number: 0022800



63305100
Tissue holder
Material: Brass
Finish: Chrome
Number: 0073800



63306100
Tissue holder
Material: Brass
Finish: Chrome
Number: 0026500



64901021
Hand dryer
Material: ABS
Finish: White
Number: 0046800



64902021
Hand dryer
Material: ABS
Finish: White
Number: 0129500



64204100
Mirror
Material: Brass
Finish: Chrome
Number: 0039000



64207100
Mirror
Material: Brass
Finish: Chrome
Number: 038325



64903021
Hair dryer
Material: ABS
Finish: White
Number: 0036500



64904021
Hair dryer
Material: ABS
Finish: White
Number: 0036000



64205100
Mirror
Material: Brass
Finish: Chrome
Number: 0133875



64205104
Mirror
Material: Brass
Finish: Titanium gold
Number: 0141750



64301100
Hair dryer
Material: Brass
Finish: Chrome
Number: 0015500



62101302
Wastebin
Material: SUS304
Polishing finish
Number: 0022500



64208100
Mirror
Material: Brass
Finish: Chrome
Number: 0158200



64209100
Mirror
Material: Brass
Finish: Chrome
Number: 0112500



62201222
Wastebin
Material: Iron
Finish: Black
Number: 0015000



62101323
Wastebin
Material: SUS304
Finish: Gun gray
Number: 0048500



64210100
Mirror
Material: Brass
Finish: Chrome
Number: 0033800



64211100
Mirror
Material: Brass
Finish: Chrome
Number: 0043800



62201221
Wastebin
Material: Iron
Finish: White
Number: 0015000



62101306
Wastebin
Material: SUS304
Finish: Rose Gold
Number: 0035000



60504 421
Soap dispenser
Material: ABS
Finish: White
Number: 0022900



64501302
Hand dryer
Material: SUS304
Polishing finish
Number: 0018500



65001301
Floor drain
Material: SUS304
Finish: Brushed
Number: 0007200



65001323
Floor drain
Material: SUS304
Finish: Gun gray
Number: 0009300



65002301
Floor drain
Material: SUS304
Finish: Brushed
Number: 0006700



65002323
Floor drain
Material: SUS304
Finish: Gun gray
Number: 0008800

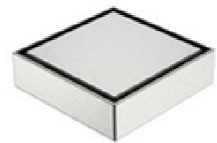

65103301
Floor drain
Material: SUS304
Finish: Brushed
Number: 0035200



65103323
Floor drain
Material: SUS304
Finish: Gun gray
Number: 0042800



65101101
Floor drain
Material: Brass
Finish: Brushed
Number: 0071800

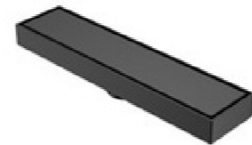

65104323
Floor drain
Material: SUS304
Finish: Gun gray
Number: 0083800



65102101
Floor drain
Material: Brass
Finish: Brushed
Number: 0064800

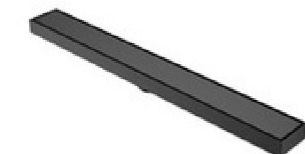

65105323
Floor drain
Material: SUS304
Finish: Gun gray
Number: 0122500



6521030
1
Floor drain
Material: SUS304
Finish: Brushed
Number: 0110800

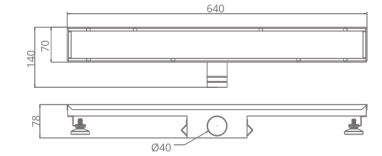

65220301
Floor drain
Material: SUS304
Finish: Brushed
Number: 0059800

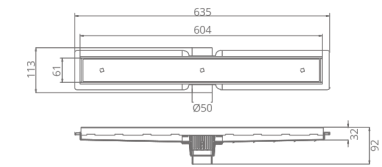

65230301
Floor drain
Material: SUS304
Finish: Brushed
Number: 0116800

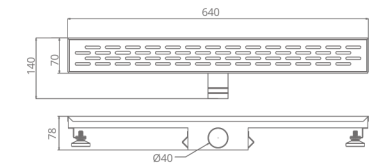

65106320
Floor drain
Material: SUS304
Brushed gold
Number: 0156800

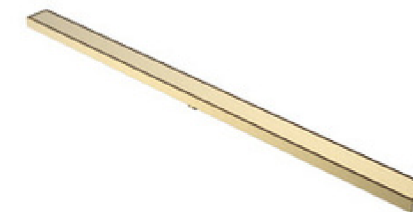
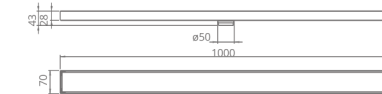

65107320
Floor drain
Material: SUS304
Brushed gold
Number: 0239800

